

A close-up photograph showing a person's hands using a white, long-handled tool called an E-Wand to adjust a window blind. The person's right hand is at the top of the tool, holding a white cylindrical cap. The left hand is further down the handle, which is being inserted into the mechanism of the blind. The background consists of horizontal white blinds with light streaming through them. The overall scene is brightly lit, suggesting an indoor setting near a window.

CURRENT

E-WANDTM
INSTALLATION MANUAL AND
USER GUIDE

E-WAND™

INSTALLATION MANUAL

AND

USER GUIDE

Please carefully and fully read the following Installation Manual and User Guide. Without proper installation and programming, your E-Wand will not perform as designed.

Please save these instructions.

Please be aware that the E-Wand may behave differently based on blind manufacturer, slat size, and tilt mechanism location.

For assistance, please contact our customer service department at 844-307-7435, or see our additional support materials at www.currentproductscorp.com/support.

Instructional Videos can be viewed by going to www.currentproductscorp.com/support or by scanning the QR Code with your smart phone.



To register your E-Wands, visit www.currentproductscorp.com/products-registration. If you prefer to register via phone, call 844-307-7435. If you prefer to mail in a registration, please go to page 37.

TABLE OF CONTENTS

Package Contents and Parts Identifier.....	4
Meet Your E-Wand.....	5
Horizontal Blinds.....	6
Vertical Blinds.....	6
Assembly and Mounting the E-Wand.....	7
Power Up.....	7
Horizontal Blinds Installation Guide.....	8
Vertical Blinds Installation Guide.....	11
Programming the E-Wand.....	13
E-Wand Programming Beeps.....	13
Programming Slat Positions.....	13
Create and Manage a Twist Group.....	17
Establishing a Twist Group.....	17
Removing an E-Wand from a Twist Group.....	19
Adding an E-Wand to a Twist Group.....	19
Making Sense of the Sensors.....	20
Sensor Positions.....	20
Sensor Features.....	21
Other Procedures.....	22
Setting the Preferred Closed Position.....	22
Realign Your E-Wand.....	22
Master Reset Your E-Wand.....	23
Setting the Favorite Position.....	23
Changing Batteries.....	24
Attaching an E-Wand Extension Handle.....	25
Converting a Horizontal Corded Tilt Blind.....	26
Quick User Guide.....	28
Safety Information and Statements.....	30
Warranty Information.....	32
Product Registration.....	37

PACKAGE CONTENTS AND PARTS IDENTIFIER

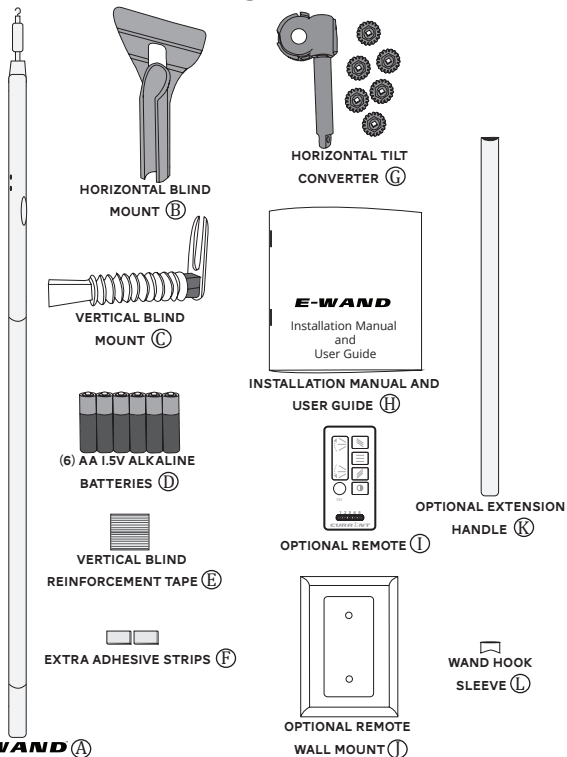

MEET YOUR E-WAND

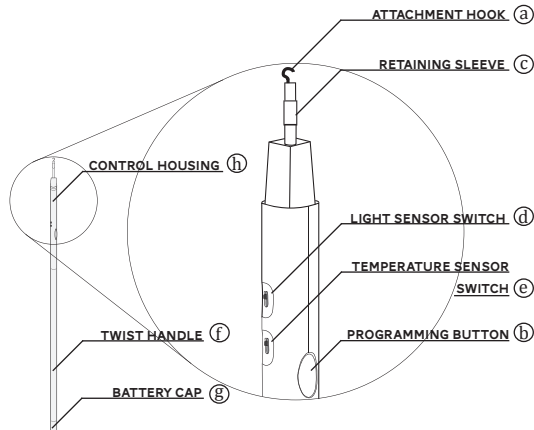

The E-Wand allows the user to motorize the slat movement for both horizontal and vertical window blinds. With a slight twist of the E-Wand, or with the optional remote control, the user can fully control the position of an individual blind's slats or a defined group of blind's slats.

Additionally, your E-Wand contains both light and temperature sensors to automate the opening and closing of the slats. This automatic movement helps provide privacy at night and can be set to open and close the slats to assist with maintaining a comfortable room temperature and help save energy.

Lastly, the E-Wand requires six (6) 1.5V Alkaline AA sized batteries (provided) which are easy to replace and will provide, in most cases, over a year between battery changes.

HORIZONTAL BLINDS

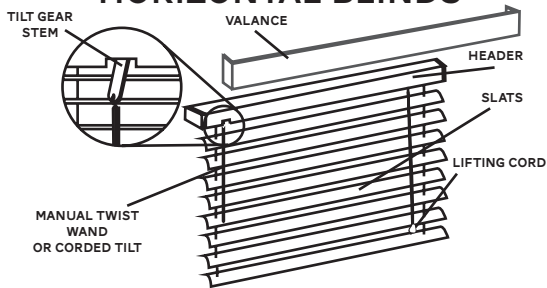

NOTE: Some blinds use a corded tilt mechanism to tilt the slats instead of a wand. If your horizontal blinds have a corded tilt mechanism, you will need to convert it to a wand tilt mechanism using the horizontal tilt gear. Instructions for converting to a wand tilt mechanism can be found on page 26.

VERTICAL BLINDS

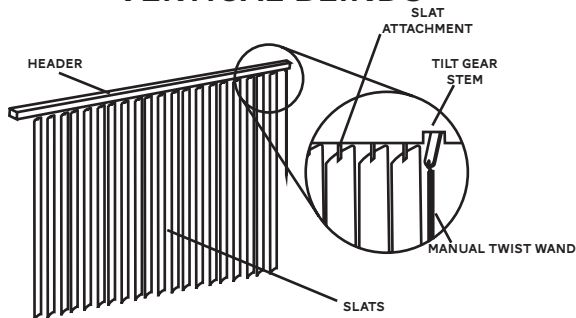

NOTE: The E-Wand is not compatible with vertical blinds that use a rope or chain to open and close the slats.

ASSEMBLY AND MOUNTING THE E-WAND

For further assistance during the assembly and mounting process, please view our online Instructional Videos at currentproductscorp.com/support.

POWER UP

Remove Battery Cap

To install the batteries, unscrew the BATTERY CAP **g** located at the bottom of the E-Wand TWIST HANDLE **f** [Fig. 1.1].

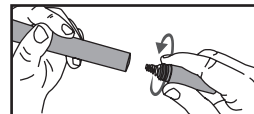

Figure 1.1; Unscrew Battery Cap

Install Batteries

Insert the batteries one after the other with the positive (+) side in first [Fig. 1.2]. Once the batteries have been inserted, screw the BATTERY CAP **g** back on to secure.

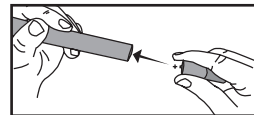

Figure 1.2; Insert Batteries

If batteries are properly installed, the E-Wand will play a confirmation tune.

HORIZONTAL BLINDS INSTALLATION GUIDE

Before installing the E-Wand, **make sure you are able to freely tilt your blinds in both directions** by turning the twist wand that originally came with your blinds. If there is significant resistance, you may need to contact your blind manufacturer. **If your blinds utilize a cord to tilt the slats, first proceed to the “Converting a Corded Tilt Blind” section in the Installation Manual and User Guide [Pg. 26].**

Make sure the blind slats are in the horizontal or fully opened position and the header is free of dirt, grime, and grease. If not, use a household cleaner to clean the header before installation.

Detach Original Tilt Wand and Attach the E-Wand

Remove original tilt wand from the tilt stem or hook.

If your blind has an open hook for the original tilt mechanism as opposed to a closed eyelet, slide the plastic SECURITY SLEEVE (L) over the tilt hook to cover the hook's gap. Leave enough room for the E-Wand (A) ATTACHMENT HOOK (a) to securely connect [Fig. 2.1].

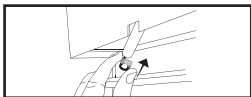

Figure 2.1; Slide Hook Sleeve onto Stem

Attach the E-Wand

Mount your E-Wand (A) [Fig. 2.2] by connecting or inserting the slat ATTACHMENT HOOK (a) to your blind's tilt gear stem or hook. Carefully push up the plastic RETAINING SLEEVE (C), [Fig. 2.3]. Rotate the E-Wand (A) until the two SENSOR SWITCHES (d) & (e) are in front and facing into the room.

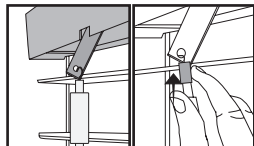

Figure 2.2; Hook Wand onto Tilt Stem

Figure 2.3; Push up Retaining Sleeve

Test Fit the Blind Mount

Perform a test fit of the HORIZONTAL BLIND MOUNT (B) by snapping the mount onto the E-Wand. Slide the mount up or down along the CONTROL HOUSING (h) until your blind's tilt gear stem and the E-Wand ATTACHMENT HOOK (a) can be seen through the cutout in the blind mount. Be sure the bottom of the horizontal blind mount is resting above the two sensor switches.

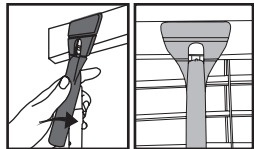

Figure 3.1; Snap on Blind Mount

Figure 3.2; Proper Positioning

Verify that the blind mount can rest completely flush to the header AND that the blind slats resting in the fully open position are not touching the E-Wand.

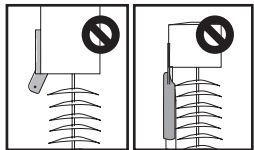

Figure 3.3; Tilt Stem Protrudes from Header Preventing a Flush Mount

Figure 3.4; Blind Slats Touch E-Wand

Make Any Necessary Adjustments

The blind mount must have a secure connection to the header. Based on the results of the two tests [Fig. 3.3 and Fig. 3.4], it may be necessary to add the supplied EXTRA ADHESIVE STRIPS (F) to your blind's header to build the mounting attachment outward [Fig. 4.1].

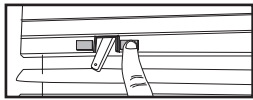

Figure 4.1; (Optional) Build out Header

If the HORIZONTAL BLIND MOUNT (B) extends beyond the top or the side of the blind's header, use scissors to trim the HORIZONTAL BLIND MOUNT (B) to fit [Fig. 4.2]. If you have a valance, make sure the top of the neck of the HORIZONTAL BLIND MOUNT (B) is even with or slightly below the bottom of the valance.

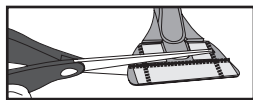

Figure 4.2; (Optional) Trim Blind Mount to Fit

Secure Blind Mount

Now that you have determined the final position of the HORIZONTAL BLIND MOUNT (B), verify the header is clean and dry and that the tube of the blind mount is snapped into place on the E-Wand, then remove the backing on the adhesive strip [Fig. 5.1] and firmly press to attach it to the blind's header.

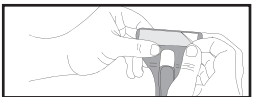

Figure 5.1; Remove Backing from Adhesive Strip to Attach it to Header

You have now completed installing your E-Wand. You may now proceed to Programming the E-Wand [Pg. 13].

VERTICAL BLINDS INSTALLATION GUIDE

Before installing the E-Wand, make sure you are able to freely tilt your blinds in both directions by turning the twist wand that originally came with your blinds. If there is significant resistance you may need to contact your blind manufacturer. **The E-Wand is not compatible with vertical blinds that use a rope or chain to tilt the slats.**

Make sure the blind slats are uniformly opened in the tilted fully opened position, then remove the original manual tilt wand.

Remove Twist Wand

Remove the manual twist wand from the vertical blinds.

Install the Vertical Blind Mount

Install the VERTICAL BLIND MOUNT (C) on the E-Wand by sliding the clear plastic bellows over the ATTACHMENT HOOK (a) until it fits snugly on the E-Wand frame [Fig. 6.1]. Install the mount so that the sensor switches will be facing the inside of the room.

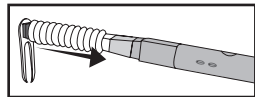

Figure 6.1; Install Blind Mount

Attach the E-Wand to the Vertical Blind

Pull down on the VERTICAL BLIND MOUNT'S (C) bellows to expose the E-Wand ATTACHMENT HOOK (a). Hook the E-Wand ATTACHMENT HOOK (a) onto the existing blind's tilt gear stem [Fig. 7.1]



Figure 7.1; Hook on E-Wand

Release the blind mount to allow the bellows to extend upwards toward the header, covering the attachment hook. Be sure the slat attachment can move through the open slot in the blind mount [Fig. 7.2].

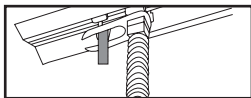

Figure 7.2; Proper Positioning

Recommended: Reinforce First Slat

Remove the adjacent vertical slat by carefully pushing the slat upward and then sideways [Fig. 8.1].

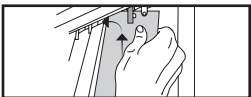

Figure 8.1; Detach First Slat

Use the included VERTICAL BLIND REINFORCEMENT TAPE (E) to reinforce the top of the first vertical slat [Fig. 8.2].

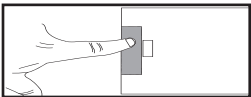

Figure 8.2; Reinforce Vertical Slat

Carefully replace the slat back onto the slat attachment hook by reversing the steps to remove the slat [Fig. 8.3]. Be sure the slat is oriented the same as the other slats within the assembly.

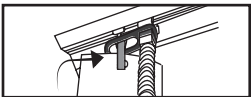

Figure 8.3; Reattach Vertical Slat

You have now completed installing your E-Wand. You may now proceed to Programming the E-Wand [Pg. 13].

PROGRAMMING THE E-WAND

For further assistance during the programming process, please view our online Instructional Videos at currentproductscorp.com/support.

E-WAND PROGRAMMING BEEPS

During programming, be conscious that there are several series of beeps that correspond with the different programming stages. Be careful to not sum up the number of beeps you have heard, for example, a SINGLE BEEP (1) and then a DOUBLE BEEP (2) is not a TRIPLE BEEP (3).

Single Beep (1)	Pairing the Remote and Grouping E-Wands
Double Beep (2)	Programming the Slat Positions
Triple Beep (3)	Setting the Favorite Position
Quadruple Beep (4)	Setting the Preferred Closed Position
Quintuple Beep (5)	Master Reset
Sextuple Beep (6)	Realign the E-Wand

Figure 9.1; Programming Beeps

PROGRAMMING SLAT POSITIONS

When programming the E-Wand, you will be listening for audible beeps to assist you through the programming steps. It is important to understand that each beep, or series of beeps, is for a specific function in a programming stage. We recommend you minimize the noise within the room while programming the E-Wand to best hear these beeps.

During the programming phase, if an error is made, the E-Wand will play a short tune. This means you must restart the programming steps for that E-Wand.

Place the E-Wand into Slat Position Programming Mode

To place the E-Wand into the Slat Position Programming Mode, press and hold the PROGRAMMING BUTTON **(b)** until you hear a DOUBLE BEEP(2), then release [Fig. 10.1].

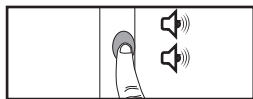

Figure 10.1; Press and Hold Programming Button

Note: Prior to hearing a DOUBLE BEEP (2), you will hear a SINGLE BEEP (1). After hearing the DOUBLE BEEP (2), release.

The E-Wand is now in Slat Position Programming Mode.

Set the First Position- Full Closed (Down for Horizontal Blinds or Left for Vertical Blinds)

Twist the E-Wand TWIST HANDLE **(f)** [Fig. 11.1] to move the slats of the blind to the FULL DOWN OR LEFT position, then release the TWIST HANDLE **(f)**.

Be careful not to over tighten slats, as over tightening can cause damage to the blind.

Press and hold the PROGRAMMING BUTTON **(b)** until you hear a SINGLE BEEP (1) [Fig. 11.2], then release.

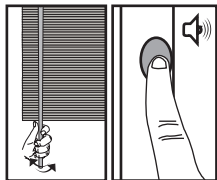

Figure 11.1; Twist Blinds to Full Closed

Figure 11.2; Push and Hold Programming Button

Set the Second Position- Full Open

Twist the E-Wand TWIST HANDLE **(f)** [Fig. 12.1] in the OPPOSITE direction than the first phase of programming to move the slats to the FULL OPEN position, then release the TWIST HANDLE **(f)**.

Press and hold the PROGRAMMING BUTTON **(b)**. You will hear a DOUBLE BEEP (2) [Fig. 12.2], then release.

Note: During twisting, if you move past the full open position, do not twist the opposite way back to full open. Instead, restart programming. To get out of programming mode, power cycle the unit by partially unscrewing and re-tightening the battery cap. You have successfully power cycled when you hear a tune.

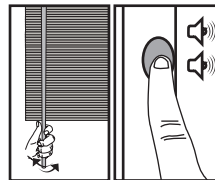

Figure 12.1; Twist Blinds to Full Open

Figure 12.2; Push and Hold Programming Button

Set the Third Position- Full Closed (Up for Horizontal Blinds or Right for Vertical Blinds)

Twist the E-Wand TWIST HANDLE **(f)** again in the SAME direction [Fig. 13.1] so the slats reach the FULL UP OR RIGHT position. **Be careful not to over tighten the slats.**

Press and hold the PROGRAMMING BUTTON **(b)**. You will hear a TRIPLE BEEP (3) [Fig. 13.2], then release.

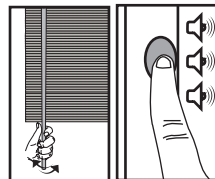

Figure 13.1; Twist Blinds to Full Open

Figure 13.2; Push and Hold Programming Button

Set the Final Position- Full Open

Twist the E-Wand TWIST HANDLE (f) in the OPPOSITE direction [Fig. 14.1] to move the slats back to the FULL OPEN position. Press and hold the PROGRAMMING BUTTON (b) until the slats begin to move [Fig. 14.2].

The slats will automatically move DOWN OR LEFT and back to the FULL OPEN position to verify that the positions have been set properly and that you have completed programming the slat positions.

Note: When twisting to the final position, if you move past the full open position, do not twist the opposite way back to full open. Instead, restart programming. To get out of programming mode, power cycle the unit by partially unscrewing and re-tightening the battery cap. You have successfully power cycled when you hear a tune.

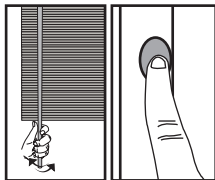

Figure 14.1;
Twist Blinds to
Full Closed

Figure 14.2;
Push and Hold
Programming
Button

CREATE AND MANAGE A TWIST GROUP (OPTIONAL)

You may create a Twist Group prior to or after installation and programming. We recommend linking E-Wands prior to installation on challenging to reach windows.

A Twist Group allows you to group multiple E-Wands together so each will respond to the manual twist movement given to any other E-Wand you have placed in the group.

ESTABLISHING A TWIST GROUP

Place the E-Wands you wish to group in Pairing Mode

On the E-Wands you wish to group together, one by one, press and hold the PROGRAMMING BUTTON (b) until you hear a SINGLE BEEP (1), then release [Fig. 15.1].

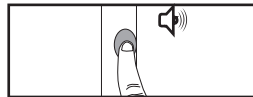

Figure 15.1; Press and Hold
Programming Button

Choose and Assign the Master E-Wand

Once you have initiated the linking sequence on EACH E-Wand, choose an E-Wand that will be centrally located in the group to designate as the “master”.



Figure 16.1; Press and Hold Programming Button

Press and hold THIS E-Wand's PROGRAMMING BUTTON (b) again until you hear a SINGLE BEEP (1) [Fig. 16.1]. You have now completed linking your E-Wands and have created a Twist Group.

To confirm the group has been properly created, each programmed E-Wand in the group will jog [Fig. 16.2]. Any E-Wands in the group that have not had their slat positions programmed will play a tune.

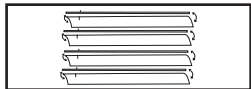

Figure 16.2; Jog

The ability to create a twist group will time out after FIVE (5) minutes of inactivity. If you have mistakenly initiated grouping on an E-Wand, simply twist the TWIST HANDLE (f) to remove from programming mode.

REMOVING AN E-WAND FROM A TWIST GROUP

In some instances, you may want to remove an E-Wand from a previously created Twist Group. To remove an E-Wand:

Press and hold the PROGRAMMING BUTTON (b) on the E-Wand you wish to remove from the group until you hear a SINGLE BEEP (1), then release.

Once more, **press and hold the PROGRAMMING BUTTON (b)** until you hear another SINGLE BEEP (1), then release.

Repeat this process to remove any additional desired E-Wands from the group.

ADDING AN E-WAND TO A TWIST GROUP

In some instances, you may want to add an E-Wand to an existing Twist Group. To add an E-Wand:

Press and hold the PROGRAMMING BUTTON (b) on the E-Wand you originally designated as the master until you hear a SINGLE BEEP (1), then release.

On any E-Wand you wish to add to the group, **press and hold the PROGRAMMING BUTTON (b)** until you hear a SINGLE BEEP (1), then release.

After all additional E-Wands have been initialized, **return to the master to press and hold its PROGRAMMING BUTTON (b)** again until you hear a SINGLE BEEP (1).

All added blinds will jog, and any prior E-Wand will beep to confirm the group has been successfully re-formed.

MAKING SENSE OF THE SENSORS

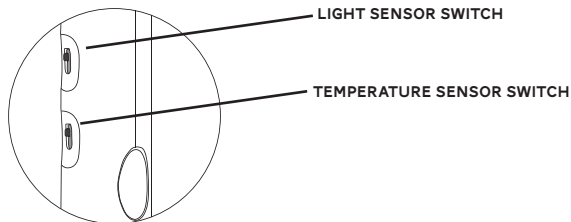

SENSOR SWITCH POSITIONS

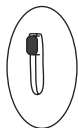

Off

Light or Temperature Sensors is off.

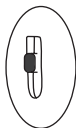

Fully Automatic

Light Sensor closes the slats at sunset and opens the slats at sunrise.

Temperature sensor opens the slats around 69°F and closes the slats around 82°F.

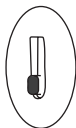

Semi-Automatic

Light sensor only closes the slats at sunset.

Temperature sensor only closes the slats around 82°F.

SENSOR FEATURES

Once the LIGHT SENSOR or TEMPERATURE SENSOR makes an automatic movement, the slats will not automatically move for another eight (8) hours.

The LIGHT SENSOR will prevent the TEMPERATURE SENSOR from opening your blinds at night to maintain your privacy.

A manual movement of an E-Wand via the TWIST HANDLE (F) or REMOTE will deactivate the automatic features for three (3) hours.

When blinds are grouped, one sensor triggered movement will move all blinds within that group.

Pro-Tip: Based on the direction your window is facing, as well as other environmental factors, different blinds may close or open at different times when using the automated features. We suggest finding the E-Wand that opens and closes at your preferred time, then grouping all E-Wands together and only having that one E-Wand's sensors activated.

OTHER PROCEDURES

SETTING THE PREFERRED CLOSED POSITION

When using the automated features, the E-Wand may close the blinds in a direction different than the direction you prefer (i.e. up or down on horizontal blinds, or left or right on vertical blinds). To change the preferred closed position:

Twist the E-Wand TWIST HANDLE (f) until the slats reach your desired closed position, then release.

Press and hold the PROGRAMMING BUTTON (b) on the E-Wand until you hear a QUADRUPLE BEEP (4). The E-Wand will now close to this set position when closed by sensor triggered events.

REALIGN YOUR E-WAND

Based on the construction of your blinds, you may notice the full open position has changed over time from it's originally programmed position. If you notice this occurrence, you can simply realign your originally programmed E-Wand slat positions.

Move the E-Wand manually by twisting the TWIST HANDLE (f) to the position you consider to be FULL OPEN.

Press and hold the PROGRAMMING BUTTON (b) until you hear a SEXTUPLE BEEP (6), then release. Your E-Wand has now been realigned to it's originally programmed positions.

MASTER RESET YOUR E-WAND

Master reset is performed to return an E-Wand to its factory default settings. All twist groups, paired remotes, and positional settings will be removed from the memory of the E-Wand.

Press and hold the PROGRAMMING BUTTON (b) until you hear a QUINTUPLE BEEP (5), then release. To confirm you want to perform a master reset, the E-Wand will play a series of monotone beeps.

After you hear the beeps, **press and hold the PROGRAMMING BUTTON** (b) **again** until you hear a SINGLE BEEP (1). Another short tune will play, and you will have successfully performed a master reset.

Master reset mode can be escaped by waiting until the mode times out, or by twisting the E-Wand TWIST HANDLE (f) after hearing the monotone beeps.

SETTING THE FAVORITE POSITION (FOR THE REMOTE CONTROL)

The FAVORITE Button on the remote control allows the user to program a slat position unique to the user which moves all slats included on that channel to the user's favorite position.

Twist the E-Wand TWIST HANDLE (f) until the desired position is reached.

Press and hold the PROGRAMMING BUTTON (b) on the E-Wand until you hear a TRIPLE BEEP (3), then release.

Your FAVORITE Button will now move that blind to the programmed favorite position. Each E-Wand can be set to have different favorite positions.

After the E-Wand is set, test by moving your blinds, then pressing the FAVORITE Button on your remote. All blinds on that channel should move to their programmed favorite position.

CHANGING BATTERIES

When the batteries are depleted, the E-Wand will play a tune instead of carrying out its normal functions.

Unscrew the Battery Cap

Using two hands, carefully and slowly unscrew the BATTERY CAP (g) [Fig. 17.1]. Batteries will naturally fall out of the battery tube, so be prepared to catch them.

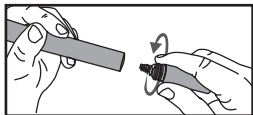

Figure 17.1; Unscrew Battery Cap

Replace Batteries

Replace bad batteries with six (6) new 1.5v Alkaline AA batteries. Always replace all batteries. NEVER mix old and new batteries. Also, NEVER use damaged or dropped batteries.

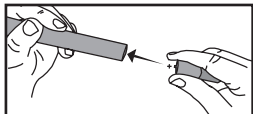

Figure 18.1; Insert New Batteries

Insert batteries with the positive (+) end first [Fig. 18.1].

Screw Battery Cap Back On

Screw the BATTERY CAP (g) back onto the end of the E-Wand. The E-Wand will play a short tune to confirm the batteries have been installed correctly.

ATTACHING AN E-WAND EXTENSION HANDLE

For blinds that are taller than average, it may be necessary to attach an E-Wand EXTENSION HANDLE (k) to the end of your E-Wand. These will double the length of the TWIST HANDLE (f).

Unscrew the Battery Cap

Carefully remove the BATTERY CAP (g) from the E-Wand [Fig. 19.1]. Be sure not to remove the batteries.

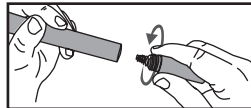

Figure 19.1; Unscrew Battery Cap

Screw on Extension Handle

Attach EXTENSION HANDLE (k) onto the end of the E-Wand. Screw tightly into place [Fig. 20.1].

Reattach Battery Cap

Reattach BATTERY CAP (g) onto the end of the EXTENSION HANDLE (k). Screw into place.

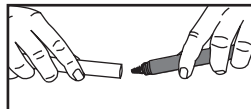

Figure 20.1; Screw on Extension Handle

CONVERTING A HORIZONTAL CORDED TILT BLIND

For further assistance with converting a corded tilt blind, please view our online Instructional Videos at www.currentproductscorp.com/support.

Many venetian blinds use a cord to tilt the slats instead of a wand. To install the E-Wand to these types of blinds, you must first replace the corded tilt gear installed on your blind with the HORIZONTAL TILT GEAR ©.

You will need to remove your blinds from the window and perform the next steps on a table or other flat surface.

Remove the Existing Tilt Mechanism

Remove the existing corded tilt gear from the blind's header. The standard tilt gear assembly is shown in [Fig. 21.1].

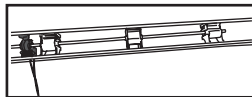

Figure 21.1; Standard Assembly

Remove the tassels by either cutting the cord or removing the knots at the end of the cord [Fig. 21.2].



Figure 21.2; Remove Tassels

Typically, the tilt gear is removed by sliding the rod out of the tilt gear, slightly bending the header and lifting the tilt gear out [Fig. 21.3].

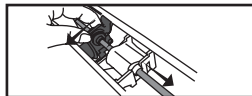

Figure 21.3; Standard Assembly

Sometimes the rods are retained in place through either a rod pin, crimps or the end brackets. While each manufacturer installs these tilt gears differently, they are relatively easy to remove.

Install the Horizontal Tilt Converter

Determine the size and shape of the rod located in your header.

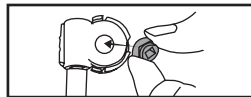

Figure 22.1; Snap in Adapter

Locate the ADAPTER from the selection supplied which matches your rod shape and size and snap into the HORIZONTAL TILT GEAR © [Fig. 22.1].

Place the gear's stem through the opening in the header and slide the rod through the gear to its original position [Fig. 22.2]. If a rod pin or the end brackets were removed while removing the corded tilt gear, replace back into their original position.

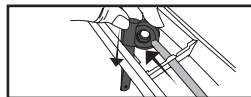

Figure 22.2; Slide Stem through Header

You have now converted your tilt mechanism. You may now proceed to Installing the E-Wand [Pg. 8].

QUICK USER GUIDE

OPERATION OF A SINGLE E-WAND

After the initial programming, simply twist the TWIST HANDLE ① of the ungrouped E-Wand to move your blind to the desired slat position and release.

CONTROLLING A GROUP OF BLINDS

Once a group is created, you can twist any E-Wand in the group and release at the desired position. All other blinds in the group will automatically move to the selected position.

OPERATION OF A SINGLE E-WAND WITHIN A GROUP OF BLINDS

Once a group has been set, twisting any E-Wand TWIST HANDLE ① will control the entire group. To operate a single E-Wand within a group, momentarily push the PROGRAMMING BUTTON ② without triggering a beep, then twist the TWIST HANDLE ① until the blinds reach the desired position.

If you accidentally trigger a beep, release the programming button. Twist the E-Wand TWIST HANDLE ①, and you will be released from the triggered programming mode.

LIGHT SENSOR AUTOMATION

The E-Wand has an internal light sensor providing the capability to automatically close your slats at night to provide full privacy in the room, and open your slats in the morning to allow in natural light.

The LIGHT SENSOR SWITCH ③ allows the user to control the light sensor and has three positions.

Top: Sensor is turned off.

Middle: Sensor will open the slats around sunrise and close the slats around sunset.

Bottom: Sensor will only close the blind around sunset.

TEMPERATURE SENSOR AUTOMATION

The E-Wand contains an internal temperature sensor providing the capability to automatically close your slats when the temperature near the window is around 82°F and open your slats when the temperature is around 69°F. This function is designed to help with energy savings and provide comfort in the room.

The TEMPERATURE SENSOR SWITCH ④ allows the user to control the temperature sensor and has three positions.

Top: Sensor is turned off.

Middle: Sensor will open the slats around 69°F and close the slats around 82°F.

Bottom: Sensor will only close the slats around 82°F.

SAFETY INFORMATION



WARNING

Read all warnings and instructions prior to installing the E-Wand. Failure to follow these instructions may result in property damage or serious personal injury.



CAUTION

Do not use the E-Wand for anything other than its intended use. Any usage of the parts of this kit outside of its intended purposes is not covered under the warranty.



CAUTION

Existing blinds may have sharp edges. Use gloves to prevent cuts or abrasions whenever removing or reinstalling blinds.

FCC: 2AJXXCP16E0060
Model: CP16E0060
IC: 22151-CP16E0060

FCC STATEMENT

This device complies with Part 15 of the FCC Rules. Operation is subject to the following two conditions:

1. This device may not cause harmful interference, and
2. This device must accept any interference received, including interference that may cause undesired operation.

Warning: Changes or modifications not expressly approved by Current Products Corp. could void the user's authority to operate the equipment.

NOTE: This equipment has been tested and found to comply with the limits for a Class B digital device, pursuant to Part 15 of the FCC Rules. These limits are designed to provide reasonable protection against harmful interference in a residential installation. This equipment generates, uses, and can radiate radio frequency energy and, if not installed and used in accordance with the instructions, may cause harmful interference to radio communications. However, there is no guarantee that interference will not occur in a particular installation. If this equipment does cause harmful interference to radio or television reception, which can be determined by turning the equipment off and on, the user is encouraged to try to correct the interference by one or more of the following measures:

- Reorient or relocate the receiving antenna.
- Increase the separation between the equipment and receiver.
- Connect the equipment into an outlet on a circuit different from that to which the receiver is connected.
- Consult the dealer or an experienced radio/TV technician for help.

RF WARNING STATEMENT

The device has been evaluated to meet general RF exposure requirements. The device can be used in portable exposure condition without restriction.

IC STATEMENT

This device complies with Industry Canada license-exempt RSS standard(s). Operation is subject to the following two conditions: (1) this device may not cause interference, and (2) this device must accept any interference, including interference that may cause undesired operation of the device.

Le présent appareil est conforme aux CNR d'Industrie Canada applicables aux appareils radio exempts de licence. L'exploitation est autorisée aux deux conditions suivantes: (1) l'appareil ne doit pas produire de brouillage, et (2) l'utilisateur de l'appareil doit accepter tout brouillage radioélectrique subi, même si le brouillage est susceptible d'en compromettre le fonctionnement.

This equipment complies with the radiation exposure limits in an uncontrolled environment. This equipment is in direct contact with the user's body under certain operating conditions. This transmitter must not be co-located or operating in conjunction with any other antenna or transmitter.

Cet équipement est conforme aux limites d'exposition aux radiations dans un environnement non contrôlé. Cet équipement est en contact direct avec le corps de l'utilisateur dans des conditions de fonctionnement normales. Cet émetteur ne doit pas être co-localisées ou opérant en conjonction avec tout autre antenne ou transmetteur.

WARRANTY INFORMATION

LIMITED WARRANTY

Current Products Corp. (the "Manufacturer") hereby warrants to Customer that the E-Wand™ (the "Product") is and will remain for a period of one (1) year from the date of delivery to Customer as evidenced by Customer's proof of purchase (the "Warranty Period"), free of defects in materials and workmanship, provided that the Product used for its intended purpose and is properly serviced in accordance with the User's Manual provided to Customer. Subject to the foregoing, if at any time during the Warranty Period the Product fails to conform to the foregoing warranty by reason of defects in materials or workmanship, Customer shall promptly notify Manufacturer in writing, and Manufacturer at its option shall repair or replace the defective Product or component part without charge to Customer, except for: (A) costs incurred in transporting the Products or component parts to and from Manufacturer's designated dealer or its manufacturing plant; and (B) charges for labor or other costs incidental to the removal or remounting of component parts repaired or replaced under this Warranty, both of which shall be borne by Customer. Notwithstanding any provision herein to the contrary, this Warranty shall not extend or obligate Manufacturer to take any action with respect to: (i) Products which have been modified, altered, installed, used or operated in a manner which is not recommended by Manufacturer, including any Products in which parts not manufactured or approved by Manufacturer have been installed; (ii) Products which have not been regularly and properly serviced in accordance with the User's Manual or which have otherwise been neglected; and (iii) ordinary wear and tear, service and maintenance and replacement items; (iv) the Product has been used, or attempted to be used, for other than the customary usage or for other than the Product's intended use; (v) the Product has been subject to mishandling, misuse, or abuse; (vi) the product has suffered damage resulting from lightning, power surges, vandalism, fire, earthquake, acts of nature, or any other cause which the product was not designed to withstand; or (vii) damage to the Product cause by battery decay or corrosion.

This Limited Warranty extends only to the original owner. This Limited Warranty is not transferable. This Limited Warranty does not cover normal wear or tear or deterioration which occurs with the passage of time. Batteries originally provided with a new product, if any, are produced by a third party and are not warranted by Manufacturer. No employee, distributor, dealer, agent or representative is authorized to change the terms of this Limited Warranty in any way, to extend the warranty time periods, or to grant additional warranties, and no attempt to do any of the foregoing will be binding upon Manufacturer.

LIMITATION OF LIABILITY

EXCEPT AS SPECIFICALLY STATED IN THE PARAGRAPHS IMMEDIATELY ABOVE, MANUFACTURER MAKES NO WARRANTY OR REPRESENTATION, EXPRESS OR IMPLIED, INCLUDING, WITHOUT LIMITATION, ANY WARRANTY OF MERCHANTABILITY OR FITNESS FOR A PARTICULAR PURPOSE. THE WARRANTY SET FORTH ABOVE AND THE OBLIGATIONS AND LIABILITIES OF MANUFACTURER THEREUNDER REPRESENT CUSTOMER'S SOLE AND EXCLUSIVE REMEDIES AND ARE EXPRESSLY MADE IN LIEU OF ANY AND ALL OTHER REMEDIES, WARRANTIES, GUARANTIES OR LIABILITIES, EXPRESS OR IMPLIED, ALL OF WHICH ARE HEREBY EXPRESSLY WAIVED BY CUSTOMER. THERE ARE NO WARRANTIES WHICH EXTEND BEYOND THE DESCRIPTION ON THE FACE HEREOF. IN NO EVENT SHALL MANUFACTURER'S LIABILITY HEREUNDER EXCEED THE PURCHASE PRICE FOR THE PRODUCTS, NOR SHALL MANUFACTURER BE LIABLE FOR ANY SPECIAL, INDIRECT, INCIDENTAL OR CONSEQUENTIAL DAMAGES OF ANY NATURE WHATSOEVER.

OTHER LEGAL RIGHTS

This warranty gives you specific legal rights, and you may also have other rights, which vary from state to state.

To register your products, please fill out the form on the next page of this manual.
Remove the page, then mail it to:

Current Products Corp.
1995 Hollywood Ave.
Pensacola, FL 32505

To register your products electronically, visit
www.currentproductscorp.com/product-registration.

To register your products over the phone, call 844-307-7435.

PRODUCT REGISTRATION

CUSTOMER INFORMATION

(Name)

(Street Address)

(City)

(State)

(Zip)

(Country)

(Email)

(Phone Number)

WHERE DID YOU BUY YOUR PRODUCTS?

(Name of Dealer or Online Merchant)

PRODUCT TYPE

SERIAL NUMBER

(e.g. "E-Wand" or "E-Wand Remote")

Mail To:

Current Products Corp.
1995 Hollywood Ave.
Pensacola, FL 32505

CURRENT



Current Products Corp.
1995 Hollywood Ave.
Pensacola, FL 32505

www.currentproductscorp.com

844-307-7435